

Macro Port 94

Underwater Lens Port

Please follow the instructions below to mount the Macro Port 94 on the housing.

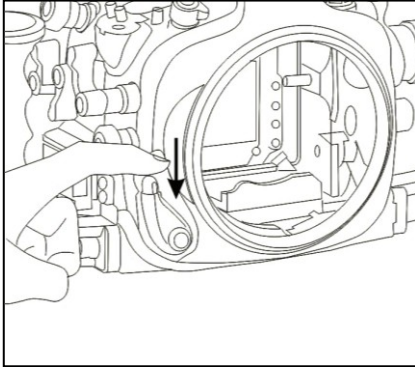

1. Remove the O-ring from the port, inspect for any damage and lightly coat it with the provided lubricant before placing it back into its groove..
2. Verify that the port opening of the housing is clean and free from foreign material.
3. Push the safety button of the port locking lever downwards.

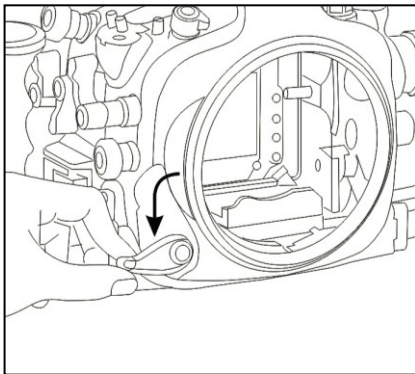

4. Turn the port locking lever to the outward position.

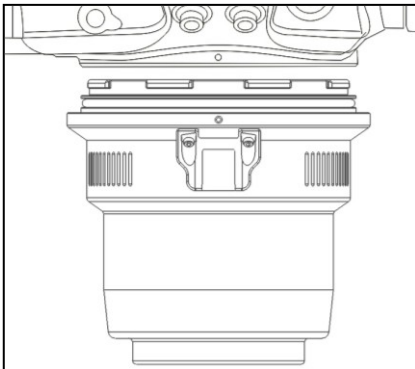

5. Align the mounting marks of the port and the housing; the marks appear as white dots on both the port and the housing.

6. Gently push the port into the opening of the housing, until it cannot go in any further.

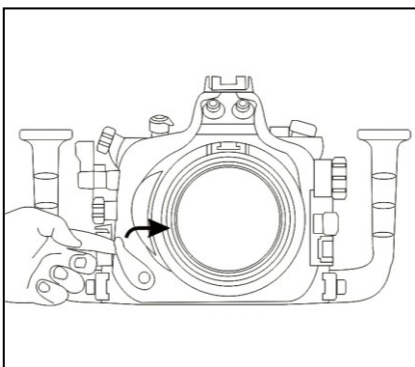

7. Lock the port into place by turning the port locking lever to the inward position. To ensure that the port is securely mounted, confirm that the green line on the safety button of the port locking lever is visible.
8. To remove the port from the housing, simply turn the port locking lever to the outward position and gently pull it out.